

# Installer Friendly Series®

## SJE-Rhombus® Type IFS

### Installation Instructions and Operation/Troubleshooting Manual

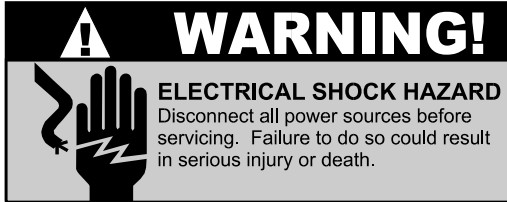

Warranty void if panel is modified.

Call factory with servicing questions:  
**1-800-RHOMBUS**  
(1-800-746-6287)

Manufactured by:

**SJE**  
**Rhombus**®

22650 County Highway 6 ■ P.O. Box 1708  
Detroit Lakes, Minnesota 56502 USA  
1-888-DIAL-SJE (1-888-342-5753)  
Phone: 218-847-1317 ■ Fax: 218-847-4617  
E-mail: customer.service@sjerrhombus.com  
Website: www.sjerrhombus.com

©SJE-Rhombus  
Printed in USA  
1022888D • Rev 12/14

This control panel must be installed and serviced by a licensed electrician in accordance with the National Electric Code NFPA-70, state and local electrical codes.

All conduit running from the sump or tank to the control panel must be sealed with conduit sealant to prevent moisture or gases from entering the panel. **NEMA 4X enclosures are for indoor or outdoor use**, primarily to provide a degree of protection against corrosion, windblown dust and rain, splashing water and hose-directed water. **Cable connectors must be liquid-tight in NEMA 4X enclosures.**

## Installation

This Installer Friendly Series® (IFS) control panel was designed to control pump(s). The controller records pump status, number of cycles, elapsed run time, current float status, and float error counts.

### Mounting the Control Panel

**Note:** The control panel should not be mounted in a location that may be subject to submersion.

1. Determine mounting location for panel. If distance exceeds the length of either the float cables or the pump power cables, splicing will be required. For outdoor or wet installation, we recommend the use of an SJE-Rhombus® liquid-tight junction box with liquid-tight connectors to make required connections. **You must use conduit sealant to prevent moisture or gases from entering the panel.**
2. Mount control panel with mounting devices furnished.
3. Determine conduit entrance locations on control panel. Check local codes and schematic for the number of power circuits required. **(Float cables require separate conduit from power and pump cables.)**

**Note:** Be sure the proper power supply voltage, amperage, and phase meet the requirements of the pump motor(s) being installed. If in doubt, see the pump identification plate for voltage/phase requirements.

4. Drill proper size holes for type of connectors being used.

**Note:** If using conduit, be sure that it is of adequate size to pull the pump cable(s) through.

5. Attach cable connectors and/or conduit connectors to control panel.

**FOR INSTALLATION REQUIRING  
A SPLICE, FOLLOW STEPS 6-10;  
FOR INSTALLATION WITHOUT A  
SPLICE, GO TO STEP 11.**

6. Determine location for mounting junction box according to local code requirements. **Do not** mount the junction box inside the sump or basin.
7. Mount junction box to proper support.
8. Run conduit to junction box. Drill proper size holes for the type of conduit used.

# Installation Instructions

9. Identify and label each wire before pulling through conduit into control panel and junction box. Make wire splice connections at junction box.
10. Firmly tighten all fittings on junction box.
11. If a junction box is not required, pull cables through conduit into control panel.
12. Connect pump wires per wiring diagram or schematic and float wires to the proper terminals as shown on the schematic.
13. Connect pump, control, and alarm incoming power conductors to proper position on terminals. See schematic for terminal connections.

**VERIFY CORRECT OPERATION OF CONTROL PANEL AFTER INSTALLATION IS COMPLETE.**

## Installation of Floats

**CAUTION:** If control switch cables are not wired and mounted in the correct order, the pump system will not function properly. Control switches need to run in separate conduit from pump and power lines.

**WARNING:** Turn off all power before installing pump wires in pump chamber. Failure to do so could result in serious or fatal electrical shock.

1. Determine your normal operating level and desired float configuration, as illustrated in **Figures 2-5**.
2. Mount float switches at appropriate levels. Be sure that floats have free range of motion without touching each other or other equipment in the basin.
3. For mounting clamp installation: place the cord into the clamp as shown in **Figure 1**. Locate the clamp at the desired activation level and secure the clamp to the discharge pipe as shown in **Figure 1**.

**NOTE:** Do not install cord under hose clamp.

4. Tighten the hose clamp using a screwdriver. Over tightening may result in damage to the plastic clamp. Make sure the float cable is not allowed to touch the excess hose clamp band during operation.

**NOTE:** All hose clamp components are made of 18-8 stainless steel material. See your SJE-Rhombus® supplier for replacements.

5. If using an optional redundant off float, mount slightly below the timer enable float.
6. The alarm float can be positioned anywhere that the alarm level is desired.

**Figure 1**

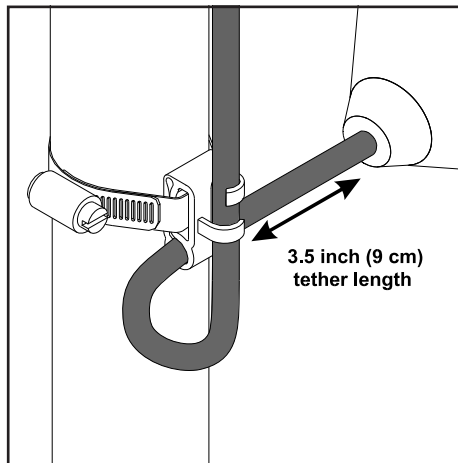

**Figure 2**  
Simplex/Duplex Timed Dose

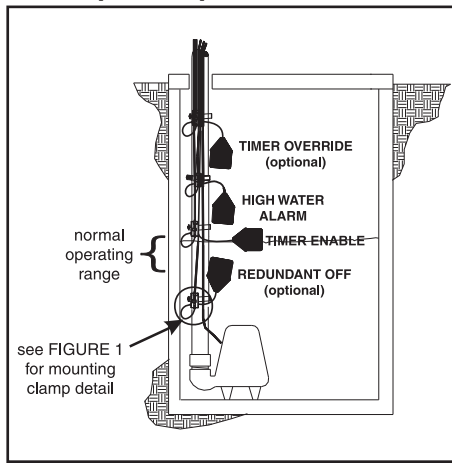

**Figure 3**  
Simplex Demand

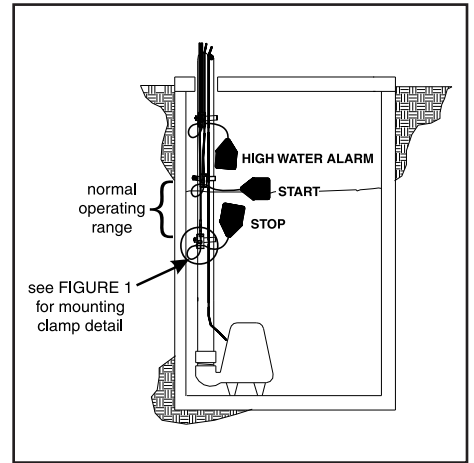

**Figure 4**  
Duplex Demand 3 Float

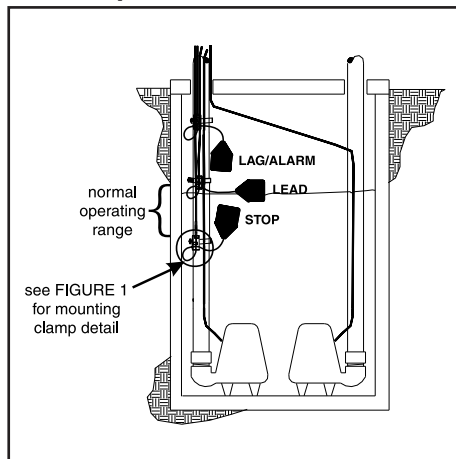

**Figure 5**  
Duplex Demand 4 Float

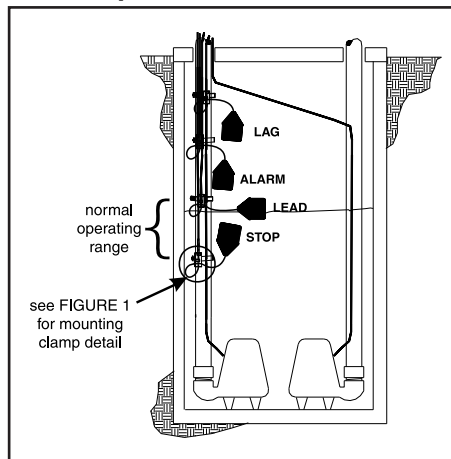

# Operations

The Installer Friendly Series® (IFS) control panel uses float switches to continuously monitor and control the liquid level in the tank.

**Hand Operation** - The stop/redundant off float must be raised to put panel in HAND operation. To override the stop/redundant off float, press and hold the HAND button. The pump runs until the HAND button is released. The panel then returns to the AUTO mode. If the stop/redundant off float is raised and the panel is placed in the HAND mode, and left in the HAND mode, the pump continues to run until the stop/redundant off float lowers. The panel then returns to the AUTO mode.

**Off Operation** - The panel is in the OFF mode.

**Auto Operation** - In time dose (t-dose) mode, when the panel is in the AUTO mode, the timer controls pump ON and OFF time as long as the low level float is raised. In demand (d-dose) mode, the stop and start floats control the pump.

**Alarm Count** - Shown on display as “AL-Ctr”, counts the number of times the alarm is activated. Note: Alarm counter does not include testing operations in the total count. High alarm, floats out of sequence & auxiliary alarm add to count.

**Green Control and Alarm Power Indicators** - (mounted on interior circuit board) Illuminates when control power and alarm power is present. If the control fuse needs replacing, the panel sounds an alarm.

**Display** - Will turn off after one minute of non-use.

**Float Indicators** - Illuminates if the float is raised. If the float is out of sequence, the panel goes into alarm mode and display shows “FE” float error.

**Timer Override Float** - Overrides the OFF time and pump will run for full dose ON time. (timed dose only, optional)

**Float Error Count** - Shown on the display as “FE-Ct”. Counts the number of times floats are out of sequence.

**Timer Override Count** - Shown on the display as “tO-Ct”. Counts the number of times the timer override float is activated. (timed dose only)

**Time left in “On” time cycle** - Shown on the display as “t-On”. Counts down the time left in the “On” cycle. (timed dose only)



**Time left in “Off” time cycle** - Shown on the display as “t-OFF”. Counts down the time left in the “Off” cycle. (timed dose only)

**Auxiliary alarm count**- Shown on the display as “AL1Ctr” or “AL2Ctr”. Counts optional auxiliary alarm counts for single phase models. Counts Pump 1 and Pump 2 fail counts for three phase models and single phase models with overloads.

## Viewing Panel Settings



With control power supplied to panel:



Press  button. The display will show  for timed dose applications, or  for demand applications.

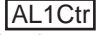

Press  button. The display will show  count in hh:mm.



Press  button. The display will show  count.

Press  button. The display will show  count. Cycle count for Duo Alarm 1 option for single phase models. **OR** Cycle count for Pump 1 Fail for three phase models and single phase models with overloads.



Press  button. The display will show  count (pump 2) in hh:mm. (duplex panels only)



Press  button. The display will show  count. (pump 2) (duplex panels only)



Press  button. The display will show  count. Cycle count for Duo Alarm 2 option for single phase models. **OR** Cycle count for Pump 2 Fail for three phase models and single phase models with overloads.



Press  button. The display will show  alarm count.

Press  button. The display will show  float error count.

Press  button. The display will show  timer override count. (timed dose mode only)



Press  button, The display will flash , then the ON time in hh:mm:ss. (timed dose mode only)

Press  button. The display will flash , then the OFF time in hh:mm:ss. (timed dose mode only)

Press  button. The display will flash either  or , then the time left in the ON or OFF cycle. (timed dose mode only)

## Program Timer On & Off Times

With control power supplied to panel:

Press and hold  button for 3 seconds until  is displayed.

The display will flash , then the time in hh:mm:ss.



### Setting pump ON (follow Section A)

Section A

Press  button to display time in hh:mm:ss.

Press  button until desired digit flashes

Press  button until desired time is achieved.



Repeat process pressing  and  buttons until desired time is reached.

Press  button to save.

# Operations

## Setting pump OFF times

Press  button. The display will flash OFF and show the OFF time in hh:mm:ss. **Repeat the instructions in Section A to set OFF times.**

Press and hold  button for 3 seconds until  is displayed.





Timer programming is complete.





## Program Pump Sequence

Program Pump sequence "Alt", "2-1" or "1-2" (duplex only)

With control power supplied to panel:

Press and hold  button for 3 seconds until  is displayed.

Press  button until  flashes with either , , or  flashing.

Press  button to display , , .

Press  button until desired sequence is achieved.

Press and hold  button for 3 seconds until  is displayed.

Pump sequence programming is complete.

## Selecting Time Dose or Demand Dose -Panels in the field

To set the panel to either Timed Dose or Demand Dose in the field:

1. Turn the control/alarm power off to the control panel.
2. Turn the pump power off to the control panel.
3. Place a small screwdriver or pen into the slot in the label on the inner door marked "DEMAND DOSE TIMED DOSE".
  - Move the dip switch (up) for demand dose
  - Move the dip switch (down) for Timed dose
4. Turn the control/alarm power on to the control panel. After the display goes blank press the "NEXT" switch.
  - The display will show d-dose for demand dose.
  - The display will show t-dose for timed dose.**WARNING:** Changing the dip switch positions will change the operation of the panel.  
**WARNING:** If changing to timed dose, be sure to set the off and on times.
5. Turn on the pump power after all the settings are changed.
6. **WARNING:** Check the panel for correct operation before leaving the site.

# Troubleshooting

## Float Controls

1. Check the floats during their entire range of operation. Clean, adjust, replace and repair damaged floats.
2. Measure the float resistance to determine if the float is operating properly.

To measure float resistance:

- a. Isolate the float by disconnecting one or both of the float leads from the float terminals.
- b. Place one ohmmeter lead on one of the float wires, and the other ohmmeter lead on the other float wire.
- c. Set the ohmmeter dial to read ohms and place on the R X 1 scale. With the float in the "off" position, the scale should read infinity (high resistance), if not replace the float.

With the float in the "on" position, the scale should read close to zero, if not replace the float. **Readings may vary depending on the accuracy of the measuring device.**

## Fuse

To check the continuity of the fuse, pull the fuse out of the fuse holder. With the ohmmeter on the R X 1 scale, measure resistance. A reading of infinity (high resistance) indicates a blown fuse that must be replaced with a fuse of the same type, voltage, and amp rating.

## Alarm Light

With power on, hold the test/normal/silence switch in the "test" position. The alarm light should turn on. If not, replace the light with that of the same type.

## Alarm Horn

With power on, hold the test/normal/silence switch in the "test" position. The alarm horn should turn on. If not, replace the horn with that of the same type.

NOTES:

---

---

---

---

---

---

---

---

---

---

---

---

---

---

---

---

---

---

---

---

---

---

---

---

**SJE-Rhombus® Five-Year Limited Warranty**

**SJE-RHOMBUS®** warrants to the original consumer that this product shall be free of manufacturing defects for five years after the date of consumer purchase. During that time period and subject to the conditions set forth below, **SJE-RHOMBUS®** will repair or replace, for the original consumer, any component which proves to be defective due to defective materials or workmanship of **SJE-RHOMBUS®**.

**ELECTRICAL WIRING AND SERVICING OF THIS PRODUCT MUST BE PERFORMED BY A LICENSED ELECTRICIAN.**

**THIS WARRANTY DOES NOT APPLY: (A)** to damage due to lightning or conditions beyond the control of **SJE-RHOMBUS®**; **(B)** to defects or malfunctions resulting from failure to properly install, operate or maintain the unit in accordance with printed instructions provided; **(C)** to failures resulting from abuse, misuse, accident, or negligence; **(D)** to units which are not installed in accordance with applicable local codes, ordinances, or accepted trade practices, and **(E)** to units repaired and/or modified without prior authorization from **SJE-RHOMBUS®**.

*Some states do not allow limitations on how long an implied warranty lasts, so the above limitation may not apply to you. Some states do not allow the exclusion or limitation of incidental or consequential damages, so the above limitation or exclusion may not apply to you. This warranty gives you specific legal rights, and you may also have other rights which vary from state to state.*

**TO OBTAIN WARRANTY SERVICE:** The consumer shall assume all responsibility and expense for removal, reinstallation, and freight. Any item to be repaired or replaced under this warranty must be returned to **SJE-RHOMBUS®**, or such place as designated by **SJE-RHOMBUS®**.

**ANY IMPLIED WARRANTIES OF MERCHANTABILITY OR FITNESS ARE LIMITED TO THE DURATION OF THIS WRITTEN WARRANTY. SJE-RHOMBUS® SHALL NOT, IN ANY MANNER, BE LIABLE FOR ANY INCIDENTAL OR CONSEQUENTIAL DAMAGES AS A RESULT OF A BREACH OF THIS WRITTEN WARRANTY OR ANY IMPLIED WARRANTY.**

**NOTICE!**  
Products returned must be cleaned, sanitized, or decontaminated as necessary prior to shipment to ensure that employees will not be exposed to health hazards in handling said material. All applicable laws and regulations shall apply.

